

Module 1: Introduction to NEXTA/DTALite: (10AM-10:30 AM)

- Two software applications: NEXTA as GUI and data hub; DTALite as DTA simulation engine
- 32_bit vs. 64_bit: 32_bit for GIS shape file importing and legacy support; 64_bit for large network: (e.g. NCSU network, 1M vehicles, 5-10 AM, 4 CPU cores, 9GB RAM, 1 hour CPU time for 20 iterations)
- Data files are in CSV format: with geometric fields (for importing from and exporting to GIS, Google Fusion Tables)
- Project folder: *.tnp file as a reference for other data files:
 - One network per project folder
 - Prefix of input, output files
 - How to manage multiple projects (load multiple projects)

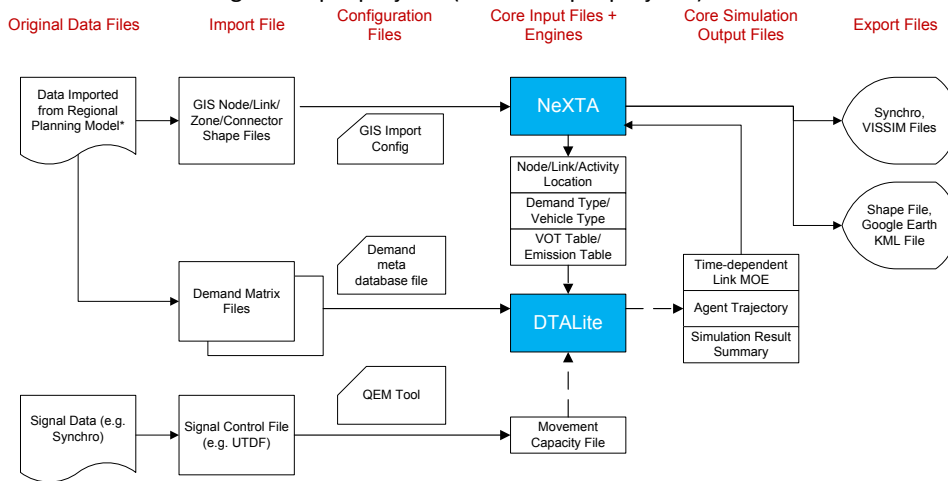

File structure:

- Different layers: different files: node, link, zone, activity locations
- Many model attribute files: node control type, link type, demand type and vehicle type
- Time representation: 24 hour (for demand and sensor data), day number= iteration number, work zone has day attributes (for modelling day-to-day learning)
- Demand meta database file: “Dynamic demand data manager”, read multiple demand files, in different format: column, matrix, agent file, DYNASMART file, different demand loading periods, additional departure time profile
- Scenario setting file: traffic flow model, traffic assignment model, scenario number for multiple scenario runs
- Scenario files for advanced modelling features: work zone, incident, tolling, VMS files
- Sensor data file: for model validation and calibration, different time period
- Output files: simulation summary, network MOE, link MOE, trajectory file

Subfolders under internal release folder

- Documentation (for data structure, users guide, QEM tool)
- Default data folder (default data attribute files)
- Sample data sets (real-world test networks)
- Importing sample data sets (GIS files, Excel, Synchro)
- Test data sets (simple networks for testing traffic flow models and other key modelling features)

Internet Resources:

- Google Code (for hosting source code, latest release, bug reporting) : <https://code.google.com/p/nexa/>
- Training website (for learning material and user forum)
 - <https://sites.google.com/site/nextadtalitetraining/>
- www.learning-transportation.org (for hosting general learning material about network modelling)

Module 2: Working through visualization features in NEXTA (West Jordan Network) (10:30AM-11AM)

1. Basic GUI features
 - a. Turn on and off GIS layers; Move around, select node and links; Toolbars for editing networks
 - b. Open project folder (CSV file format)
2. View/Edit data files in NEXTA's "project" menu
 - a. Node/link/zone/activity location
 - b. Demand meta database
 - c. Scenario files
3. Integration with assignment model
 - a. Traffic flow model; Assignment method
4. Advanced visualization functions of NEXTA
 - a. 24-hour Time control/Clock bar
 - b. Volume (bandwidth), density, speed
 - c. Animation and queue: (turn off node layer and bandwidth)
5. Sensor-related display
 - a. Turn on sensor layer to see sensor data/locations
 - b. Activate sensor data table through right click
 - c. Validation Plot; and zoom to the link
6. Path-related display
 - a. Manually select a path: travel time over the time
 - b. Import path file
 - i. Simulated vs. observed travel time series
 - ii. Contours of density, speed and V/C
 - c. Export path summary file to Excel file to do a column chart
7. Vehicle and Summary Charts
 - a. Examining route choice decisions
 - b. X axis and Y axis: 1 hour and average travel time
 - c. Export all summary statistics to Excel
8. Data exporting to Google Earth /GIS package
 - a. 2D KML, 3D KML, GIS shape files
 - b. Google Earth visualization
 - c. Zone level display: *adjust height/color*

Module 2.2: Importing network and demand data from a regional planning model (11:30AM-12:00PM)

Learning Goals:

1. Understand how to export GIS shapefiles from CUBE
2. Understand how to prepare importing configuration

Step 1: Open and prepare VISUM network, export GIS shape files

- Open the provided Maryland Statewide model network files in Cube
- Change network to WGS 84 coordinate system (Menu > Network > Network parameters, under Spatial reference system)
- Check the available data: link types, links, nodes, zones, matrices...
- Export GIS shape files through Menu > File > Export > Shapefile
 - o Give the base file name (i.e. 35S_shapefile) and export nodes, links, zones, zone centroids and connectors
 - o The corresponding files will be written to the destination folder
- Export demand matrix through _____

Step 2: Prepare the necessary CSV files

- Copy import_GIS_settings, input_demand, input_demand_meta_data, input_link_type and input_node_control_type CSV files from any sample data set to the destination folder
- Prepare the import_GIS_settings file for the exported network for node, link, zone, centroid and connector shapefiles, as well as default settings
 - o Hint: use any GIS software (such as Q GIS) to read the key values for each layer
- Prepare input_link_type and input_node_control_type files
 - o Hint: use List link types and List nodes in VISUM to read corresponding values
- Set input_demand_meta_data to read the corresponding demand matrix, or copy the demand matrix into the input_demand CSV file

Step 3: Import the network into NeXTA

- Menu > File > Import > GIS Planning Data Set
- Save the network as a *.tnp file
- Check imported network (coordinate system, link, node, demand...)
- Run simulation and perform analysis

Module 3: Introduction to DTA modelling principles (20 min)

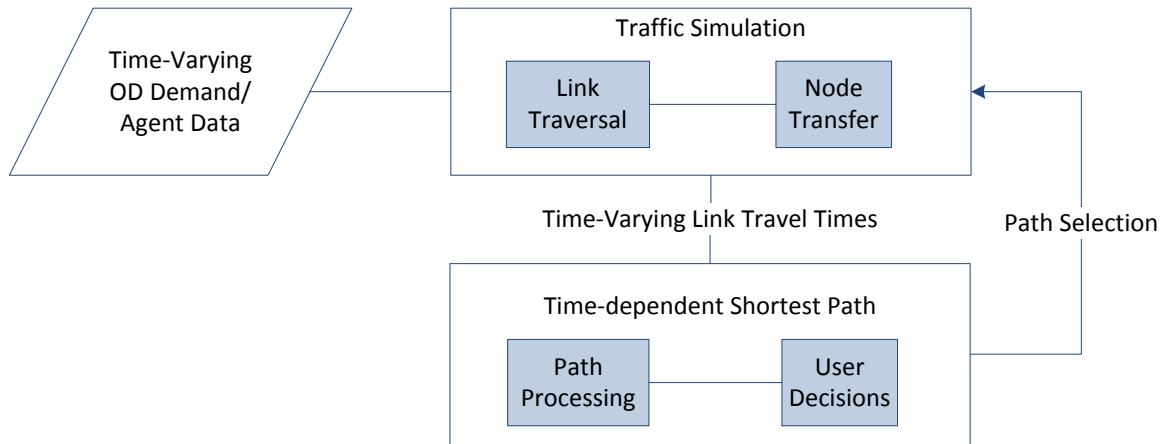

Typical Simulation-based Dynamic Traffic Assignment Modelling Framework

	Key modelling component	Notes
D	Dynamic demand, dynamic capacity	
T	Traffic flow models, link model, node model, bottlenecks (lane drop, merge and diverge, signalized intersections)	
A	Equilibrium assignment and gap functions, Day-to-day learning; agent-based routing	
Lite	Light-weight modelling features: <ol style="list-style-type: none"> 1. Computational efficiency (parallel computing for both traffic flow model and agent-based routing) 2. Signal representation (link-based, and movement-based effective green time) 3. Traffic flow model on freeway 	

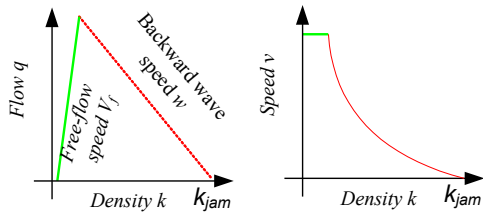

Fundamental diagram for Newell's simplified kinematic wave model

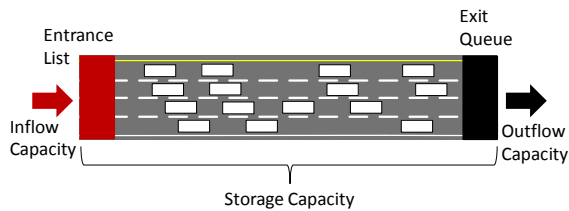

Link traversal step: outflow, inflow, and storage capacity constraints

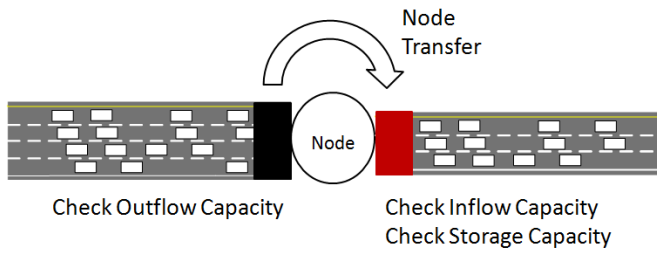

Node transfer: Move vehicles between links, subject to capacity constraints

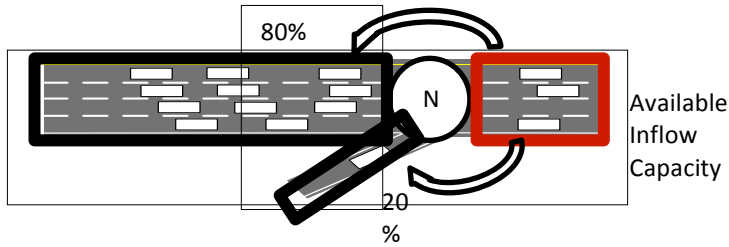

Inflow capacity allocation in DTALite using lane-based proportional model

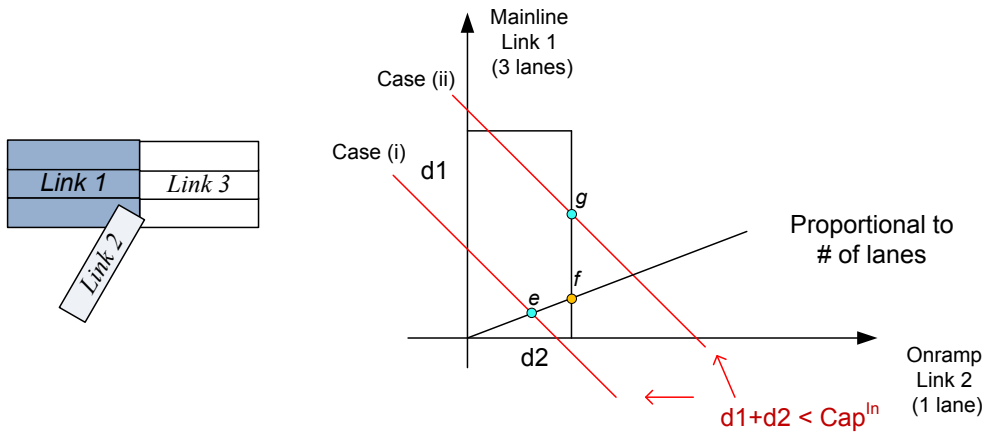

Detailed capacity allocation at merge nodes

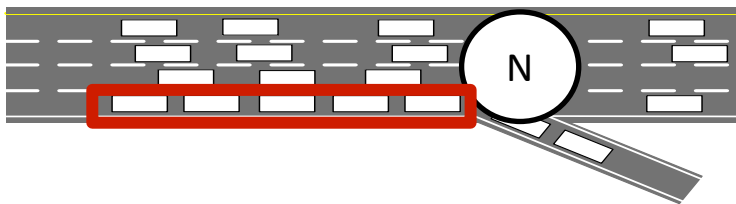

Diverge nodes: Inflow constraint relaxation to handle first-in-first-out (FIFO) at off-ramp bottlenecks

Link speed = 11.4, link density = 93.3
 Shockwave speed = 6.73 mph,
 Propagation time per mile = 8.9 min;
 Propagation time for 6 miles (from node 3 to node 9) = $8.9 \times 6 = 53.4$ min
 Observation: 8:05 AM – 7:15 AM = 50 min;
 Link speed = 13 mph: density close to 90 vehicles per mile per lane

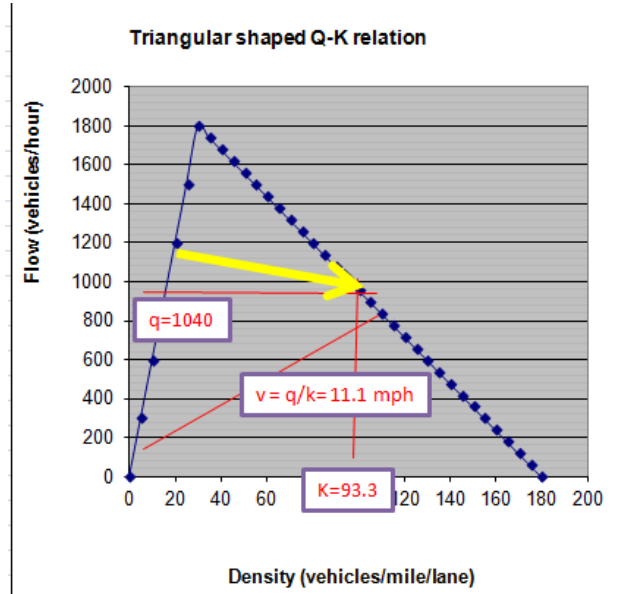
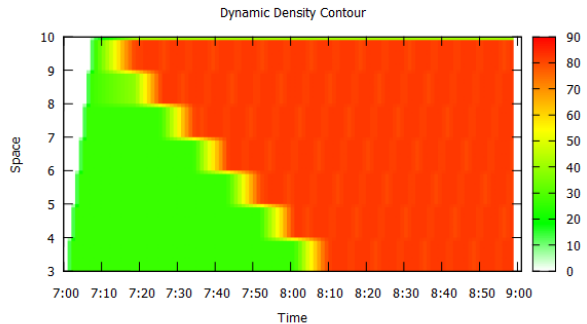

5. 20 iterations; demand level = 1.3
 User equilibrium; Relative gap function; After 5 iterations

6. 40 iterations; demand level = 1.3
 Check 15-min gap function

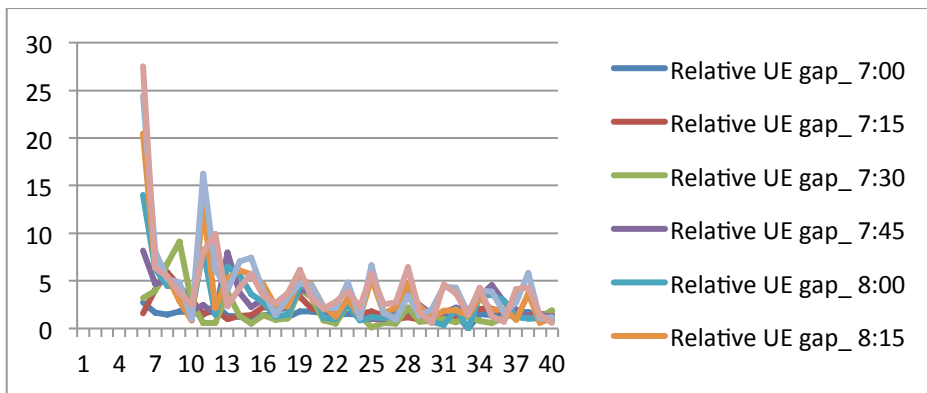

7. 40 iterations: demand level = 1.5
 Three paths are used; including the third path with FFTT = 17 min
 After 8AM, third path is used.

Average travel time on three paths through vehicle path analysis

8. Add \$0.50 toll on link 3->4

VOT = \$10 per hour, additional equivalent travel time = $\$0.5/\10×60 min /hour= 3 min
 VOT = \$20 per hour, additional equivalent travel time = $\$0.5/\20×60 min /hour= 1.5 min
 VOT = \$30 per hour, additional equivalent travel time = $\$0.5/\30×60 min /hour= 1 min

Check VOT distribution and travel time through Summary Chart

Category	WITHOUT TOLL: Avg Travel Time (min)	WITH TOLL: Avg Travel Time (min)	Avg Toll Cost (\$)
\$0-\$10	16.03	16.21	0
\$10-\$20	16.01	14.06	0.34
\$20-\$30	15.97	13.23	0.48
\$30-\$40	16.01	13.17	0.48
\$40-\$50	15.81	13	0.5
\$60-\$70	15.82	12.99	0.5

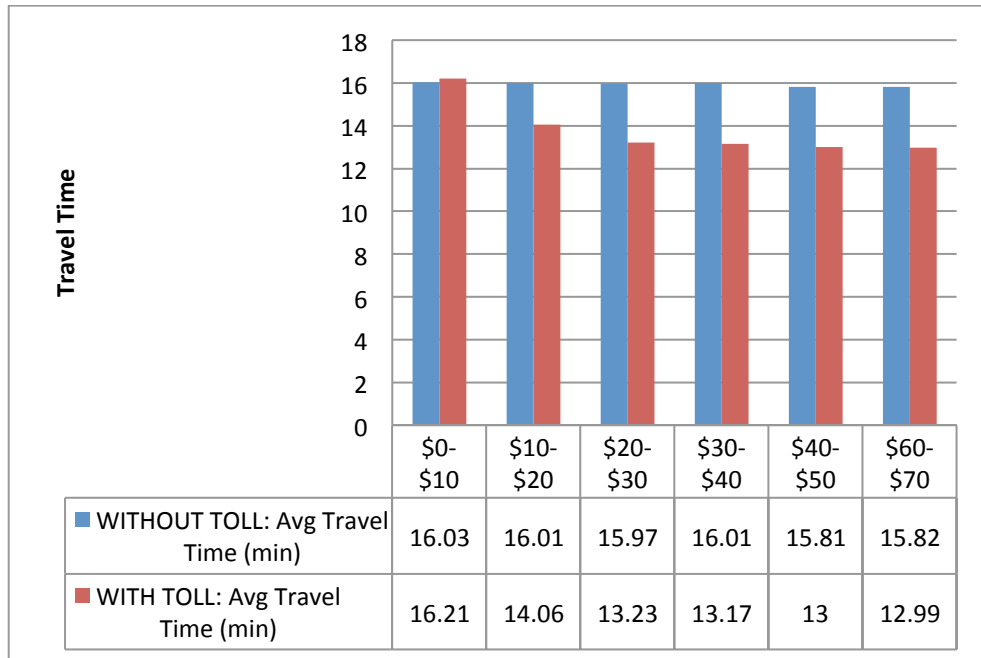

Check where the low-income travelers are diverted to, through vehicle path dialog

Path No	Count	Percentage	Travel Time (min)	Distance (mile)	Speed (mph)	Toll Cost(\$)
1	7294	67.5	15.8	11	41.8	0
2	3211	29.7	16.4	8	29.3	0
3	295	2.7	17.1	17	59.8	0
Path No	Count	Percentage	Travel Time (min)	Distance (mile)	Speed (mph)	Toll Cost(\$)
1	7203	66.7	13.1	11	50.5	0.5
2	3297	30.5	16.1	8	29.8	0
3	300	2.8	17.1	17	59.8	0

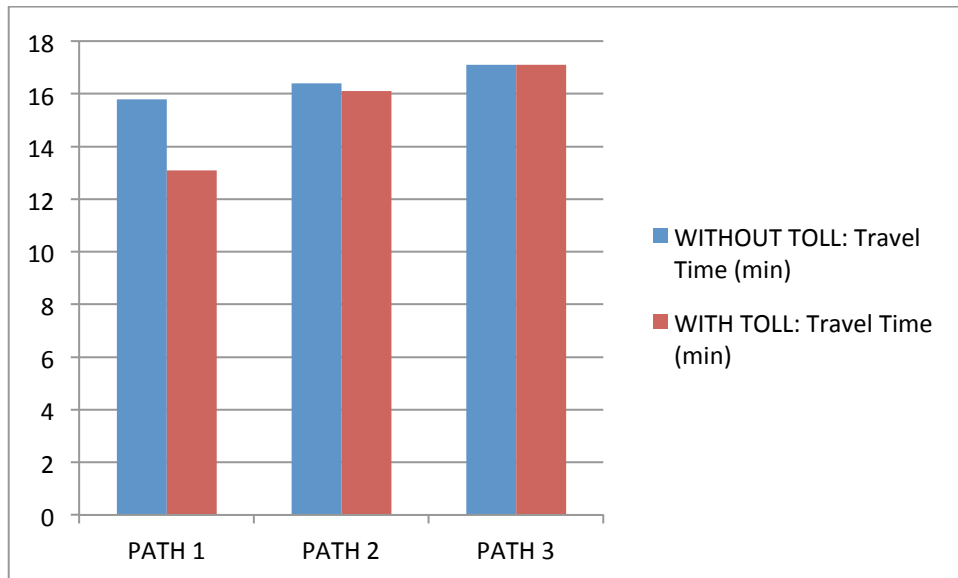

9. Add HOV toll by modifying `input_demand_meta_data.csv`
Total toll revenue: 3601 (regular toll) vs. 3327 (HOV toll)